

PORTOFINO

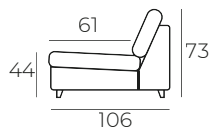

Comfort

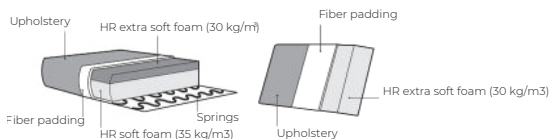

1. Upholstery



* Leather and fabric upholstery contain the same number of stitches.

2. Legs



IMPORTANT:

Upholstered furniture is handmade using soft materials, therefore measurements can vary in all modules by up to **±2 cm**. Modules and combinations shown in 2D drawings are left-sided. Modules and combinations can be mirrored from left to right.

Modules

ALL ELEMENTS ARE POSSIBLE LEFT OR RIGHT

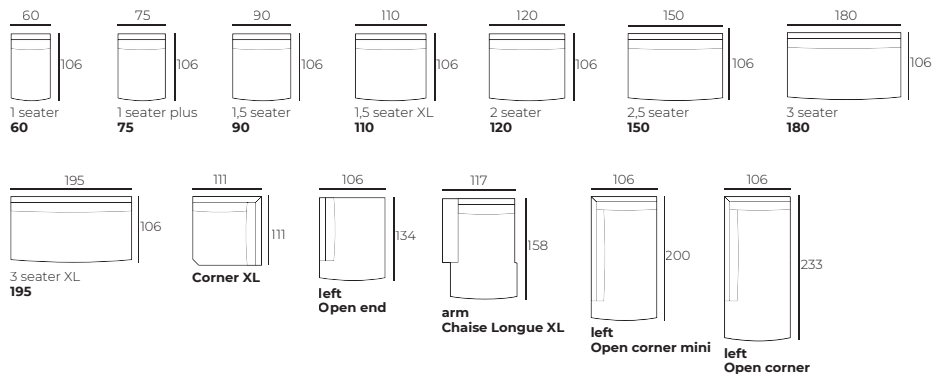

PORTOFINO

Modules with armrest

ALL ELEMENTS ARE POSSIBLE LEFT OR RIGHT

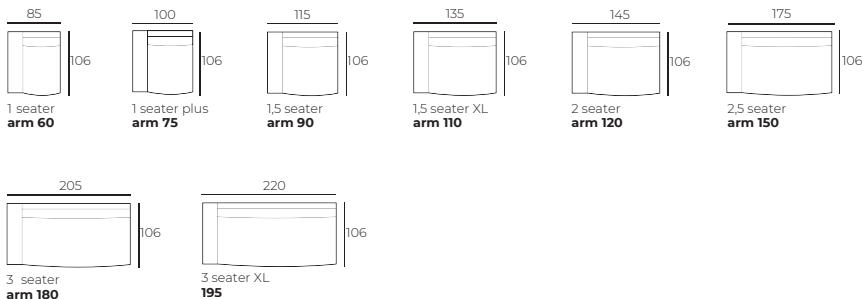

Combinations

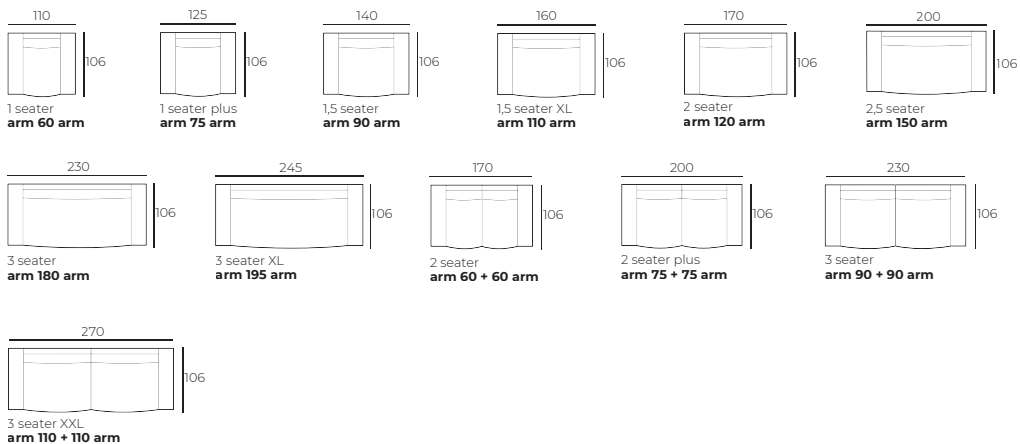

Accessories

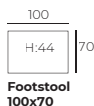

BRUTUS



Comfort

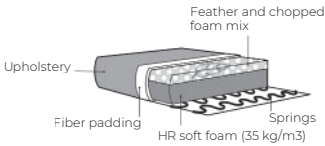

Deco cushion

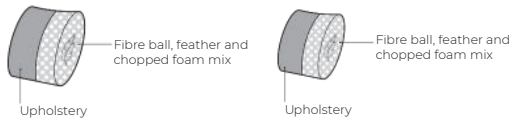

1. Upholstery



* Leather upholstery may require more stitches than fabric upholstery.

2. Armrest



3. Multicolour option



4. Legs



IMPORTANT:

Upholstered furniture is handmade using soft materials, therefore measurements can vary in all modules by up to **+/-2 cm**. Modules and combinations shown in 2D drawings are left-sided. Modules and combinations can be mirrored from left to right. For an additional fee, the sides of each seater module can be covered in fabric.



Loose cushions



Feathers



Removable 3 cm

BRUTUS

Modules (Measurements with BURROW armrest)

ALL ELEMENTS ARE POSSIBLE LEFT OR RIGHT

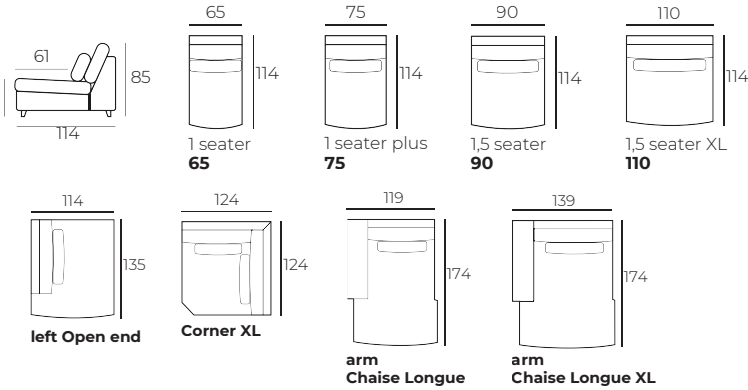

Modules (Measurements with BURROW armrest)

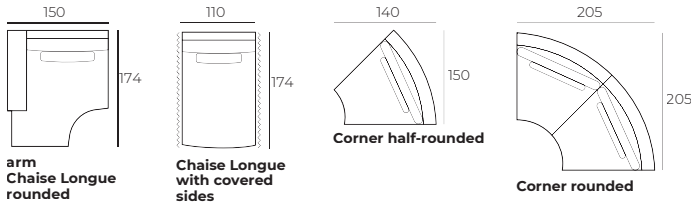

Modules with armrest (Measurements with BURROW armrest)

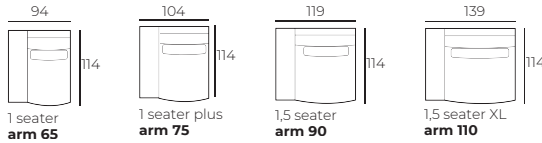

Combinations (Measurements with BURROW armrest)

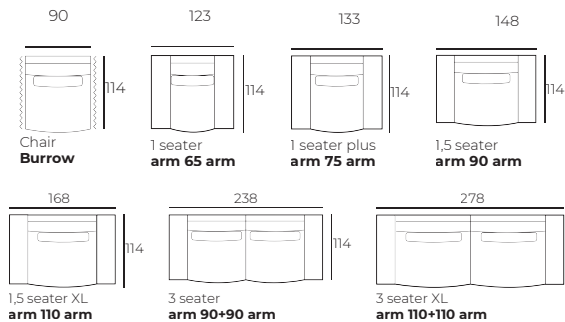

Footstool

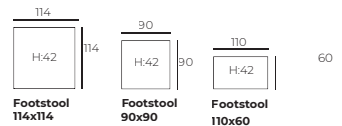

ADAM

PRODUCT INFORMATION

MEASUREMENTS*:

	1,5maxPL	E	1,5maxAL	DmaxR
WIDTH	155	115	135	155
HEIGH	87	87	87	87
DEPTH	106	106	106	190

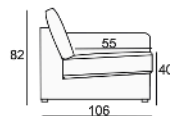

* Dimensions may be differences +/- 3%, depending on the choice and configuration upholstery. Tolerance for dimensions of final product rises, due to the characteristic of model and fabric that has been chosen by client.

STANDARD:

Fixed upholstery

Plastic legs

SEAT: filled in with foam HR-3532

BACK: filled in with crumb foam mixed with polyester siliconed fibre

ELEMENTS:

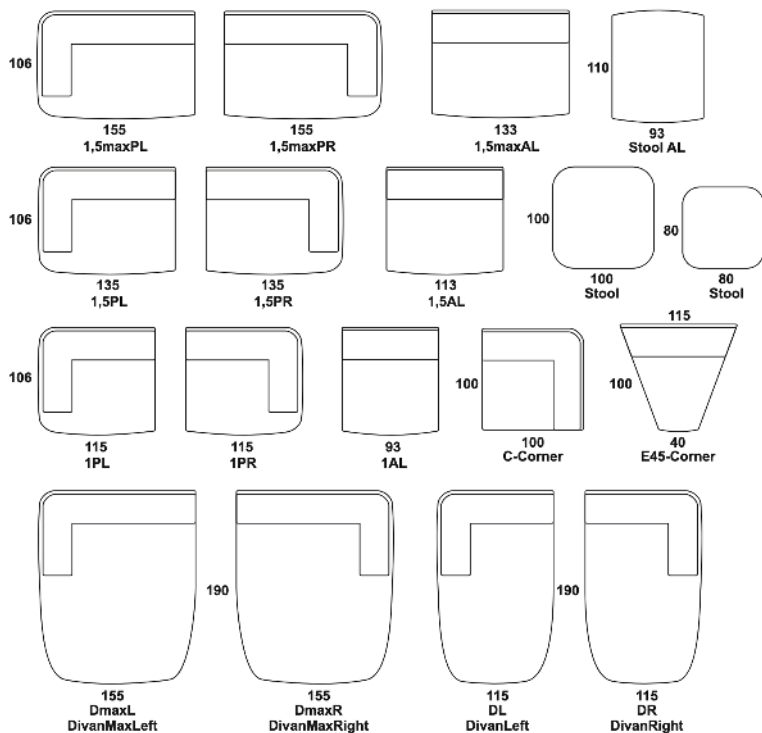



ASTUCE

INTERIOR + DECO

7 JAAR

Beste ASTUCE klanten,

ASTUCE bestaat **7 jaar!**

Daar moet natuurlijk op geklonken worden! 🎉

Daarom nodigen we graag iedereen uit tijdens ons **feestelijk verjaardagsweekend** in mei om dit samen met ons te vieren!

We zetten het weekend goed in met een **Late Night Shopping op vrijdagavond** en doorheen het volledige weekend zijn er heel wat mooie kortingen & leuke prijzen te scoren!

Tot dan? 📍

LEUKE WINACTIES,
KORTINGEN & CADEAUS VOOR ELKE KLANT!

 LOURDESSTRAAT 6, 9041 GENT

 @ASTUCEINTERIOR

 WWW.ASTUCE-INTERIOR.BE

VRIJDAG 3 MEI
Late Night Shopping
17-22u

ZATERDAG 4 MEI
10-18u

ZONDAG 5 MEI
10-18u



ASTUCE

7^{de} JAAR

WIN JE AANKOOP TERUG

PLAATS JE BESTELLING TUSSEN 30 APRIL EN 5 MEI EN MAAK KANS OM JE VOLLEDIGE AANKOOPBEDRAG TERUG TE WINNEN!

10% KORTING

OP ELKE NIEUWE BESTELLING

DRINKS, BITES &
GIFTS FOR EVERYONE



ASTUCE

TAPIJT NODIG?

KIJK ZEKER EENS TUSSEN ONZE STALEN!

HAD JE GRAAG MEER INFO OVER:

- KLEUREN
- AFMETINGEN
- VORMEN
- ONDEHOUD
- MATERIALEN

WIJ BEANTWOORDEN MET PLEZIER
AL JOUW VRAGEN!

RUG
CORNER



AST
UCE

HULP NODIG BIJ HET KIEZEN VAN EEN NIEUW TAPIJT?

ONZE TAPIJTEN ZIJN BESCHIKBAAR IN VELE
VORMEN, MATEN, KLEUREN, MATERIALEN &
AFMETINGEN.

VRAAG GERUST MEER INFO OVER :
AFMETINGEN / TAPIJTEN OP MAAT
MOGELIJKE MATERIALEN
ONDERHOUD
PRIJZEN

WE LOVE TO HELP YOU!

RUG CORNER

HULP NODIG BIJ HET
KIEZEN VAN EEN NIEUW
TAPIJT?

VRAAG GERUST MEER INFO OVER
AFMETINGEN / TAPIJTEN OP MAAT
VORMEN / MOGELIJKE MATERIALEN
STRUCTUREN / ONDERHOUD
PRIJZEN

WE LOVE TO HELP YOU!

ALPS



Comfort

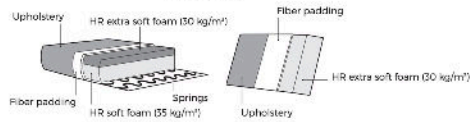

1. Upholstery



* Leather and fabric upholstery contain the same number of stitches.

2. Legs



IMPORTANT:

Upholstered furniture is handmade using soft materials, therefore measurements can vary in all modules by up to **±2 cm**.
Modules and combinations shown in 2D drawings are left-sided. Modules and combinations can be mirrored from left to right.

Modules

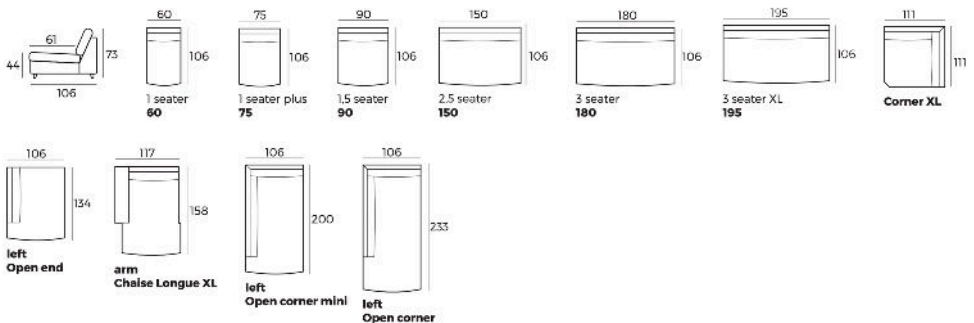

SWISS



Comfort

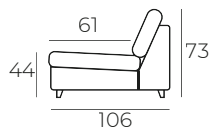
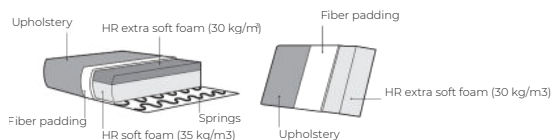

1. Upholstery



* Leather and fabric upholstery contain the same number of stitches.

2. Legs



IMPORTANT:

Upholstered furniture is handmade using soft materials, therefore measurements can vary in all modules by up to **±2 cm**. Modules and combinations shown in 2D drawings are left-sided. Modules and combinations can be mirrored from left to right.

Modules

ALL ELEMENTS ARE POSSIBLE LEFT OR RIGHT

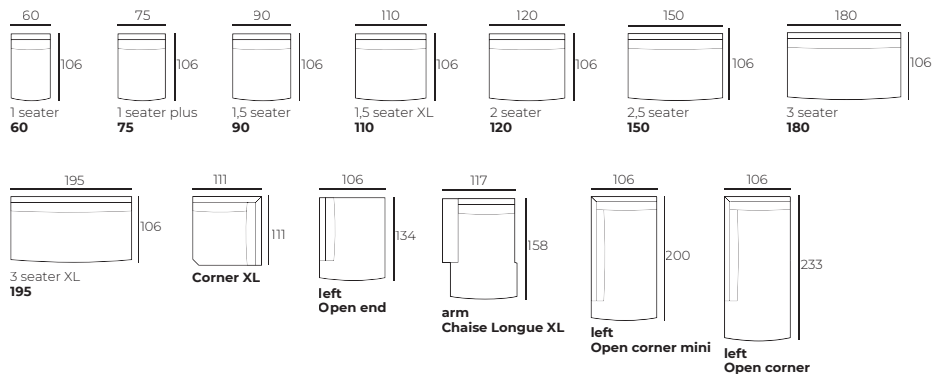

TRIN

PRODUCT INFORMATION

MEASUREMENTS:

	3,5PL	TR
WIDTH	192	152
HEIGHT	90	90
DEPTH	110	132

Dimensions may be differences +/- 4%, depending on the choice and configuration upholstery. Tolerance for dimensions of final product rises, due to the characteristic of model and fabric that has been chosen by client.



DECO CUSHIONS PER ELEMENT:

Sofas: 2 x 45x45

PL/PR,DL/R,TL/R,C: 1 x 50x50 1 x 45x45 1 x 40x40

Chair: 1 x 45x45

STANDARD:

Fixed upholstery

Wooden legs

SEAT: filled in with HR-3538 foam

BACK: filled in with HR-3020 foam

ELEMENTS:

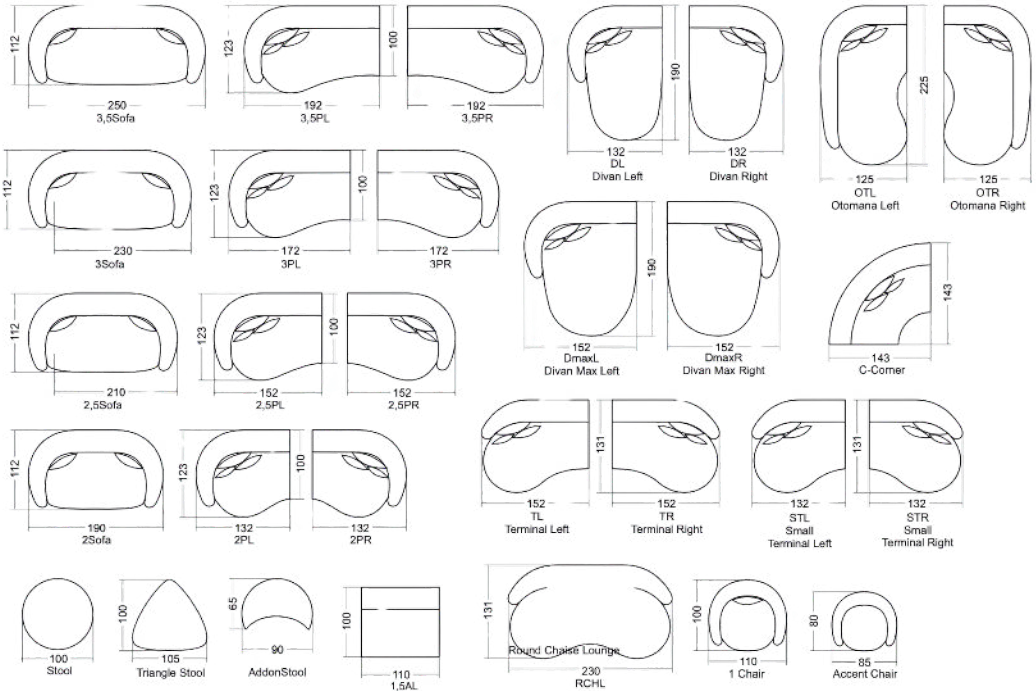

CLOVER

Modules

ALL ELEMENTS ARE POSSIBLE LEFT OR RIGHT

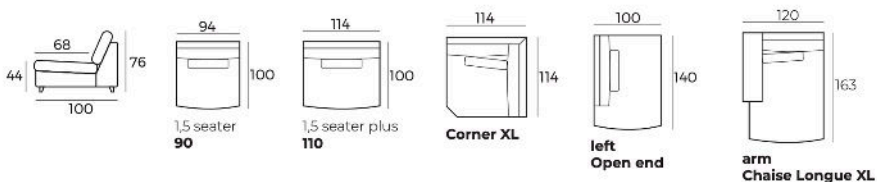

Modules with armrest

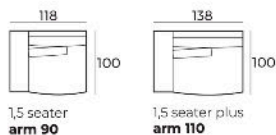

Combinations

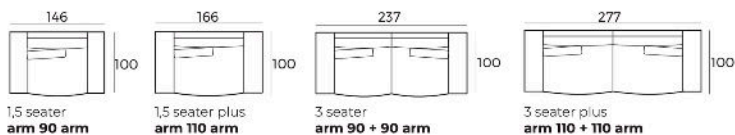

Accessories

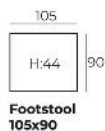



ASTUCE
VIERT



DAG VAN
DE KLANT

5 OKTOBER 2024

COSMO

039 0001	Kleur	65x130	80x150	80x230	120x170	133x195	160x230	200x250	200x290	240x300	240x340	300x400
6926	White	*	*	*	*	*	*	*	*	*	*	*
2211	White linen	*	*	*	*	*	*	*	*	*	*	*
6611	Linen	*	*	*	*	*	*	*	*	*	*	*
6699	White silver	*	*	*	*	*	*	*	*	*	*	*
9999	Silver	*	*	*	*	*	*	*	*	*	*	*
2244	Gold	*	*	*	*	*	*	*	*	*	*	*
8822	Rusty brown	*	*	*	*	*	*	*	*	*	*	*
4422	Green	*	*	*	*	*	*	*	*	*	*	*

SQUARE		
	160x160	200x200
6926	*	*
2211	*	*
6611	*	*
6699	*	*
9999	*	*
2244	*	*
8822	*	*
4422	*	*

ROUND				
	DIA 120	DIA 160	DIA 200	
6926	*	*	*	
2211	*	*	*	
6611	*	*	*	
6699	*	*	*	
9999	*	*	*	
2244	*	*	*	
8822	*	*	*	
4422	*	*	*	

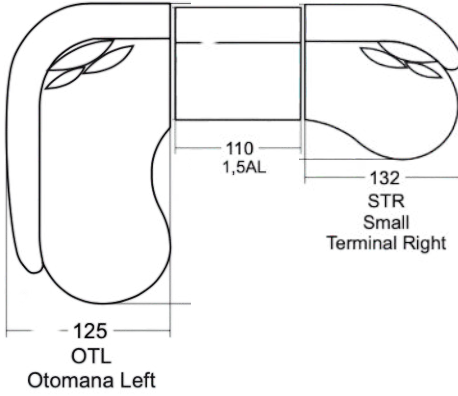
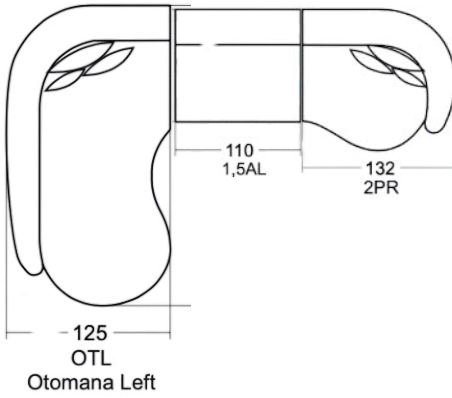

BIRDY

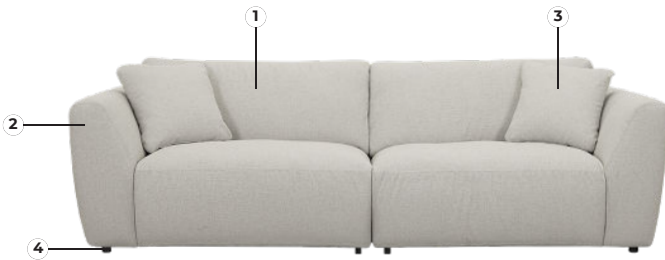

Comfort

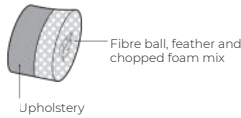
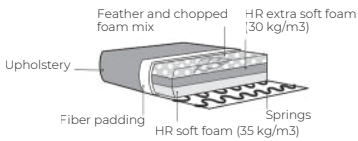

1. Upholstery



* Leather upholstery may require more stitches than fabric upholstery.

2. Armrests



1. MORGА
W 28 x D 106 x H 66



2. MOSS
W 35 x D 106 x H 66



3. KNOLL
W 38 x D 106 x H 66

3. Multicolour option



4. Legs



IMPORTANT:

Upholstered furniture is handmade using soft materials, therefore measurements can vary in all modules by up to **+/-2 cm**. Modules and combinations shown in 2D drawings are left-sided. Modules and combinations can be mirrored from left to right.

For an additional fee, the sides of each seater module can be covered in fabric.



Loose fit



Feathers



Fix cushions

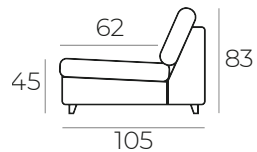

MALMO

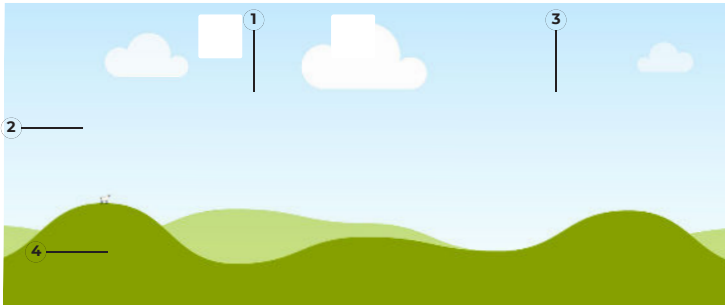

Comfort

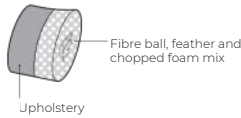
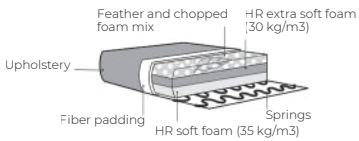

1. Upholstery



2. Armrests



1. MORGА
W 28 x D 106 x H 66



2. MOSS
W 35 x D 106 x H 66



3. KNOLL
W 38 x D 106 x H 66

3. Multicolour option



4. Legs



IMPORTANT:

Upholstered furniture is handmade using soft materials, therefore measurements can vary in all modules by up to **+/-2 cm**. Modules and combinations shown in 2D drawings are left-sided. Modules and combinations can be mirrored from left to right. For an additional fee, the sides of each seater module can be covered in fabric.



Loose fit



Feathers



Fix cushions

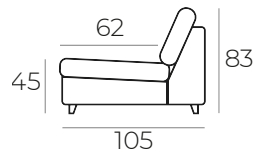

MALMO



Comfort

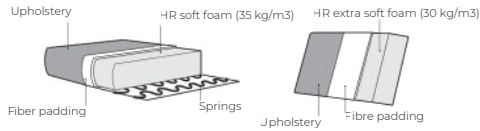

1. Upholstery



Leather



Fabric

* Leather upholstery may require more stitches than fabric upholstery.

2. Legs



524
Plastic



640
Wooden

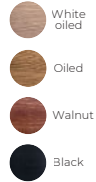

IMPORTANT: Upholstered furniture is handmade using soft materials, therefore measurements can vary in all modules by up to **+/-2 cm**.

Scale 1:100

Measurements

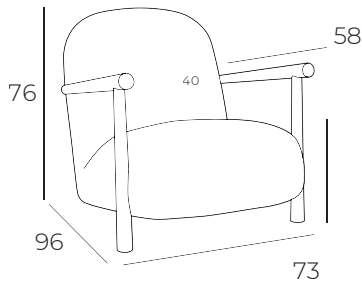

Chair
MALMO

BIRDY

Modules (Measurements with MORGA armrest)

ALL ELEMENTS ARE POSSIBLE LEFT OR RIGHT

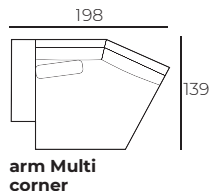
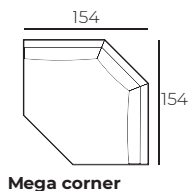
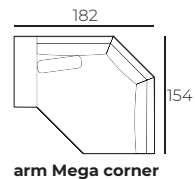
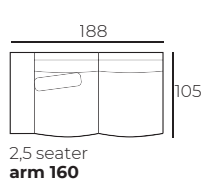
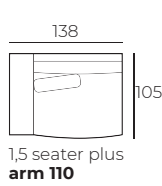
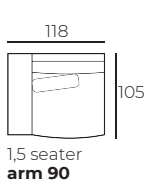
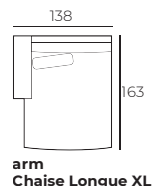
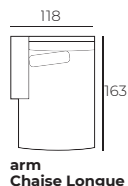
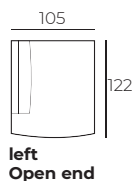
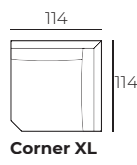
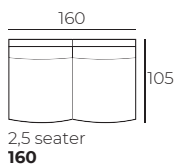
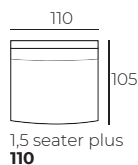
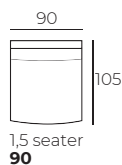

Combinations (Measurements with MORGA armrest)

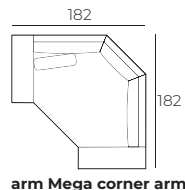
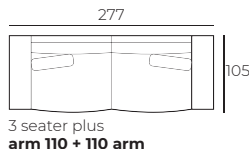
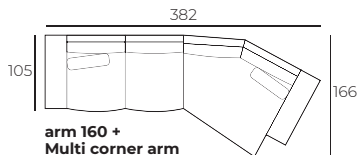
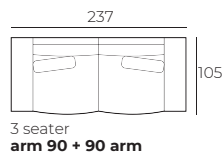
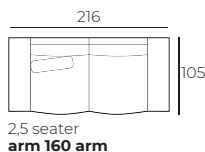
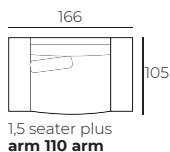
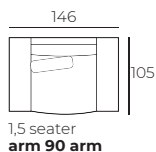

Accessories

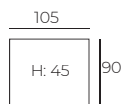

**Footstool
105x90**

EMILY

UPHOLSTERY



COMFORTS



COVERS

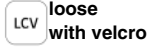

SPECIAL



extra dimensions

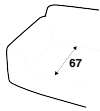

depth of seat

legs



no. 173

wood

Sits reserves the right to change construction of products and components used due to improving durability of product and customer satisfaction without any further notice. Explicit \pm 2 cm tolerance of all elements sizes.

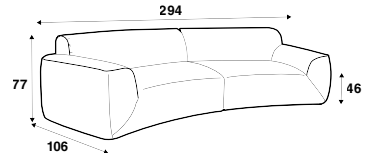
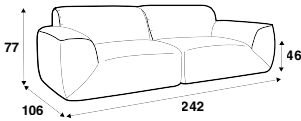

set 1

armchair wide left + armchair wide right

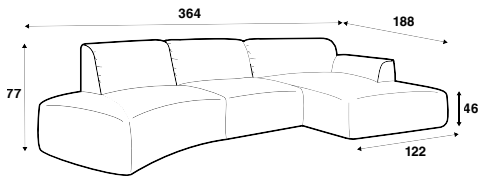

set 2

2 seater round left + 2 seater round right

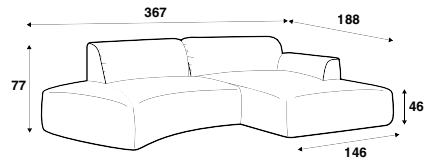

set 3 right / or left

bench round left / or right + armchair wide without armrests + chaiselongue right / or left

set 4 right / or left

bench round largeleft / or right + chaiselongue wide right / or left

modular system

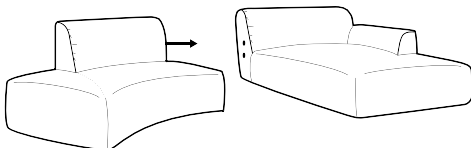

EMILY

elements of modular system

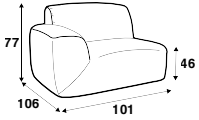

**armchair
left / or right**

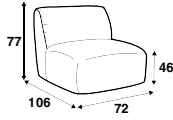

**armchair
without armrests**

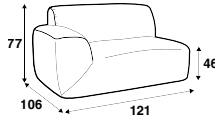

**armchair wide
left / or right**

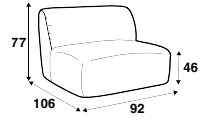

**armchair wide
without armrests**

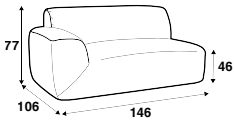

2 seater left / or right

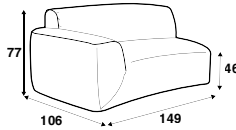

2 seater round left / or right

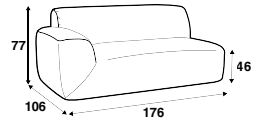

2,5 seater left / or right

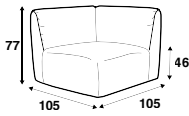

corner 90°

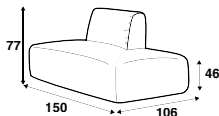

bench right / or left

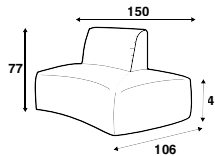

**bench round
right / or left**

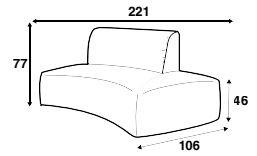

**bench round large
right / or left**

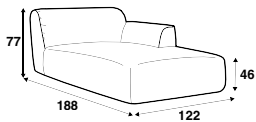

chaiselongue right / or left

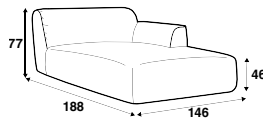

chaiselongue wide right / or left

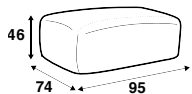

footstool 95x74

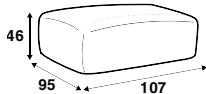

footstool 107x95

Contempo

PRODUCT INFORMATION

STANDARD:

Fixed upholstery

SEAT: Filled in with HR3020 foam

BACK: Filled in with HR3020 foam

FRAME: Filled in with PTA2443 foam

MEASUREMENTS:

	1AL
WIDTH	85
HEIGHT	71
DEPTH	100

Dimensions may be differences +/- 3%, depending on the choice and configuration upholstery. Tolerance for dimensions of final product rises, due to the characteristic of model and fabric that has been chosen by client.

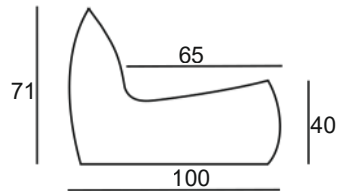

ELEMENTS:

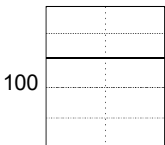

85
1AL

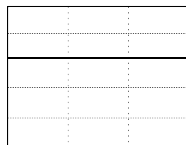

130
2AL

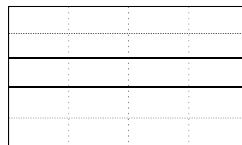

172
3AL

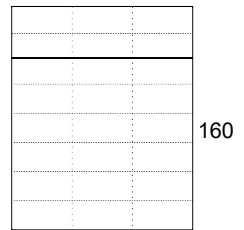

130
D-Divan

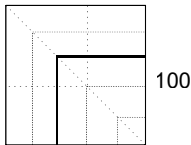

100
C-Corner

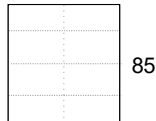

80
O-Stool

RIO

PRODUCT INFORMATION

STANDARD:

Fixed upholstery

SEAT: Filled in with HR3020 foam

BACK: Filled in with HR3020 foam

FRAME: Filled in with PTA2443 foam

MEASUREMENTS:

	1AL
WIDTH	85
HEIGHT	71
DEPTH	100

Dimensions may be differences +/- 3%, depending on the choice and configuration upholstery. Tolerance for dimensions of final product rises, due to the characteristic of model and fabric that has been chosen by client.

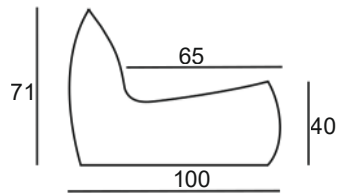

ELEMENTS:

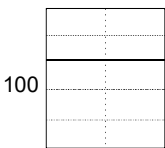

85
1AL

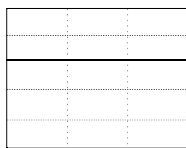

130
2AL

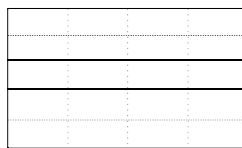

172
3AL

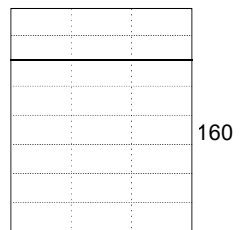

130
D-Divan

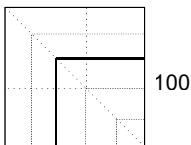

100
C-Corner

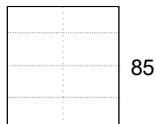

80
O-Stool

VELUTTO

ZITHOOGTE: 40CM HOOGTE ZETEL: 65CM

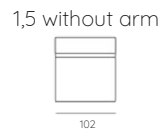
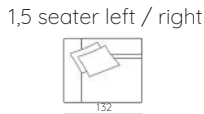
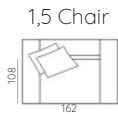
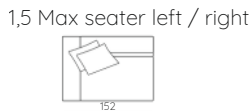
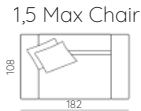
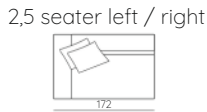
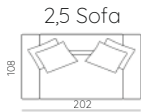
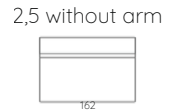
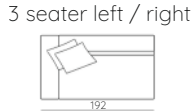
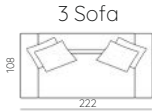
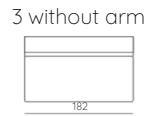
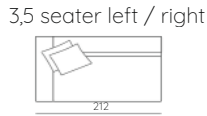
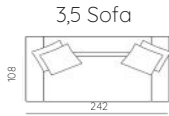

Divan left / right

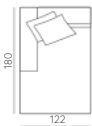

Divan Max left / right

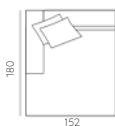

Divan XL left / right



Divan XL max left / right

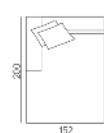

Terminal left / right

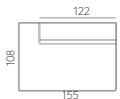

OT Otomana left/right

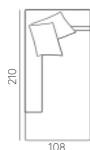

Stool 108x108



Stool 90x70



Corner



VELUTTO

3,5 Sofa

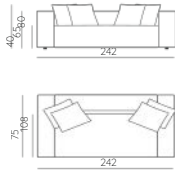

3,5 seater ft / right

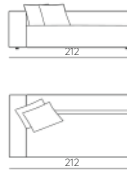

3,5 without arm

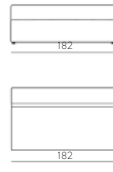

3 Sofa

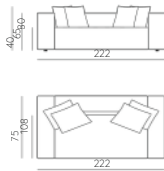

3 seater left / right

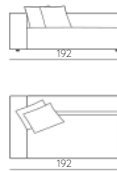

3 without arm



2,5 Sofa

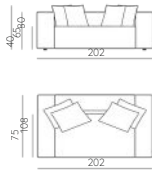

2,5 seater left / right

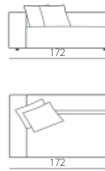

2,5 without arm

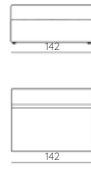

1,5 Max Chair

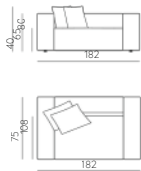

1,5 Max seater left / right

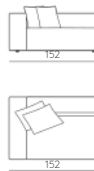

1,5 Max without arm



1,5 Chair

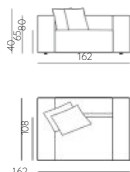

1,5 seater left / right



1,5 without arm



VELUTTO

3,5 Sofa



3,5 Position left



3,5 Position right



3,5 Arm less

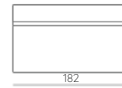
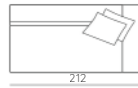
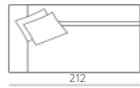
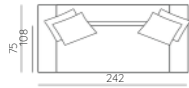
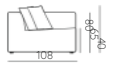
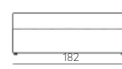

3 Sofa

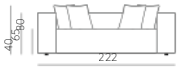

3 Position left



3 Position right



3 Arm less

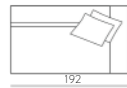
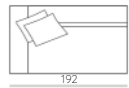
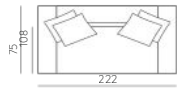
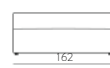

2,5 Sofa

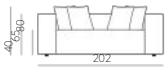

2,5 Position left



2,5 Position right



2,5 Arm less

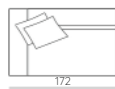
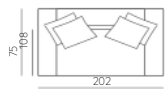

1,5 Max Chair



1,5 Max Position left



1,5 Max Position right



1,5 Max Arm less

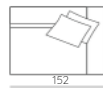
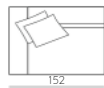
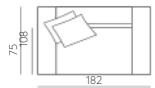

1,5 Chair

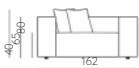

1,5 Position left



1,5 Position right



1,5 Arm less

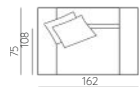

Golden Ribbon

LITTO

IN SHOWROOM: 200X100X75
OOK MOGELIJK IN 240X100

AFWERKING: OAK FINEER, WALNUT FINEER, ZWART GELAKT



€1240

ARON

IN SHOWROOM: 200X110X76
OOK MOGELIJK IN 250X110 - 300X110

AFWERKING: DONKERBRUIN / ZWART MANGOHOUD



€1399

BOBBIE

IN SHOWROOM: 215X110x76

AFWERKING: DONKERBRUIN FINEER / LICHTBRUIN FINEER



€1399

JOSH

IN SHOWROOM: 250X110X77
OOK MOGELIJK IN 300X110

AFWERKING: BRUIN / NATUREL



€1599

PIASTRO

IN SHOWROOM: DIA 115X76
OOK MOGELIJK IN DIA 150X76

AFWERKING: KALKPLEISTER
MOGELIJKE KLEUREN: TERRACOTTA / GRIJS-BEIGE / GEBROKEN WIT



€1399

AIKU

IN SHOWROOM: 200X100X76
OOK MOGELIJK IN 240X120X76

AFWERKING: WALNUT / MOUNTAIN ASH



€735

AIKU

IN SHOWROOM: DIA 140X76
AFWERKING: WALNUT / MOUNTAIN ASH



€965

MORTEX

IN SHOWROOM: 220X100X76
KAN VOLLEDIG OP MAAT / IN VERSCHILLENDE VORMEN EN AFMETINGEN /
OOK ORGANISCH, ROND... KEUZE IN AFWERKING POTEN -
VERSCHILLENDE KLEUREN MOGELIJK

SALONTAFEL OP MAAT OOK MOGELIJK



€4400

TRAVERTIN

IN SHOWROOM: 220X100X
KAN VOLLEDIG OP MAAT / IN VERSCHILLENDE VORMEN EN AFMETINGEN /
OOK ORGANISCH, ROND... KEUZE IN AFWERKING POTEN -
VERSCHILLENDE KLEUREN MOGELIJK



€4400

